

KENWOOD

CD PLAYER

DP-M5560

DP-M3360



INSTRUCTION MANUAL

KENWOOD CORPORATION

This instruction manual is used for two models.
Model availability and features (functions) may differ
depending on the country and sales area.

For your records

Record the serial number, found on the back of the unit, in the spaces designated on the warranty card, and in the space provided below. Refer to the model and serial numbers whenever you call upon your dealer for information or service on this product.

Model _____ Serial Number _____

Unpacking

Unpack the unit carefully and make sure that all accessories are put aside so they will not be lost.

Examine the unit for any possibility of shipping damage. If your unit is damaged or fails to operate, notify your dealer immediately. If your unit was shipped to you directly, notify the shipping company without delay. Only the consignee (the person or company receiving the unit) can file a claim against the carrier for shipping damage.

We recommend that you retain the original carton and packing materials for use should you transport or ship the unit in the future.

Accessories

Audio cord 1
System control cord 1
Magazine 1
(With 6 disc trays)

(DP-M5560 only)
Remote control unit 1
Batteries (R6/AA) 2

Except for U.S.A., Mexico, Canada
and Australia
AC plug adaptor 1

Contents

Caution: Read the pages marked carefully to ensure safe operation.

Special feature	2	Listening from the desired track ...	9
Before applying power	2	Program playback	10
Safety precautions	2	Playing desired tracks in	
System connections	3	desired order (PGM mode)	10
Controls and indicators	4	Repeated playback	12
Operation of remote		Random playback	13
control unit (DP-M5560 only)	5	Playing tracks in a random order ..	13
Before operation	6	Timer operations	13
Before playing CDs	7	Editing	14
Loading a disc into the magazine ..	7	To edit a disc	14
Loading a magazine	7	Incase of difficulty	16
Normal playback	8	Specifications	16
Playing a CD from the begining	8		

Special feature

 **Caution:** Read this page carefully to ensure safe operation.

- Utilizing a mechanism with a magazine that can accommodate 6 discs + 1 disc tray The CD player changer can playback 7 discs in succession.
- Program playback The program mode allows you to play desired tracks of 7 discs in the order you want to listen to. A maximum of 20 selections can be entered in memory.
- EDIT function When recording tunes from one or more CDs onto a tape, this function edits the tunes to ensure that the tunes fit within the specified tape length and that the last tune on either side does not get cut off in the middle.
- Random playback Random playback function that automatically selects disc No. and track No.

Before applying power

Units are designed for operation as follows.

- U.S.A., Mexico and Canada 120 V only
- U.K. and Australia 240 V only
- Europe (Except for U.K.) 230 V only
- Other countries 110-120 / 220-240 V switch

For the United Kingdom

Factory fitted moulded mains plug

1. The mains plug contains a fuse. For replacement, use only a 13-Amp ASTA-approved (BS1362) fuse.
2. The fuse cover must be refitted when replacing the fuse in the moulded plug.
3. Do not cut off the mains plug from this equipment. If the plug fitted is not suitable for the power points in your home or the cable is too short to reach a power point, then obtain an appropriate safety approved extension lead or adapter, or consult your dealer.
If nonetheless the mains plug is cut off, remove the fuse and dispose of the plug immediately, to avoid a possible shock hazard by inadvertent connection to the mains supply.

AC voltage selection

This unit operates on 110 - 120 or 220 - 240 volts AC. The AC voltage selector switch on the rear panel is set to the voltage that prevails in the area to which the unit is shipped. Before connecting the power cord to your AC outlet, make sure that the setting position of this switch matches your line voltage. If not, it must be set to your voltage in accordance with the following direction.

AC voltage selector switch

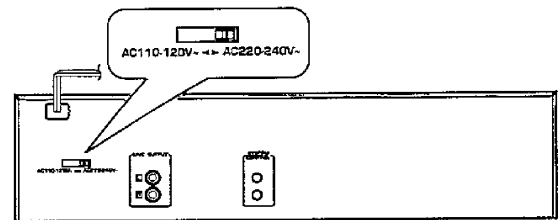





Move switch lever to match your line voltage with a small screwdriver or other pointed tool.

Note: Our warranty does not cover damage caused by excessive line voltage due to improper setting of the AC voltage selector switch.

Safety precautions

WARNING: TO PREVENT FIRE OR ELECTRIC SHOCK, DO NOT EXPOSE THIS APPLIANCE TO RAIN OR MOISTURE.

	<div style="border: 1px solid black; padding: 5px; display: inline-block;"> <p>CAUTION RISK OF ELECTRIC SHOCK DO NOT OPEN</p> </div>		
<p>CAUTION: TO REDUCE THE RISK OF ELECTRIC SHOCK, DO NOT REMOVE COVER (OR BACK). NO USER-SERVICEABLE PARTS INSIDE, REFER SERVICING TO QUALIFIED SERVICE PERSONNEL.</p>			
	<p>THE LIGHTNING FLASH WITH ARROWHEAD SYMBOL, WITHIN AN EQUILATERAL TRIANGLE, IS INTENDED TO ALERT THE USER TO THE PRESENCE OF UNINSULATED "DANGEROUS VOLTAGE" WITHIN THE PRODUCT'S ENCLOSURE THAT MAY BE OF SUFFICIENT MAGNITUDE TO CONSTITUTE A RISK OF ELECTRIC SHOCK TO PERSONS.</p>		
	<p>THE EXCLAMATION POINT WITHIN AN EQUILATERAL TRIANGLE IS INTENDED TO ALERT THE USER TO THE PRESENCE OF IMPORTANT OPERATING AND MAINTENANCE (SERVICING) INSTRUCTIONS IN THE LITERATURE ACCOMPANYING THE APPLIANCE. ...</p>		

System connections

Make connections as shown below. When connecting the related system components, refer also to the instruction manuals of the related components.
Do not plug in the power lead until all connections are completed.

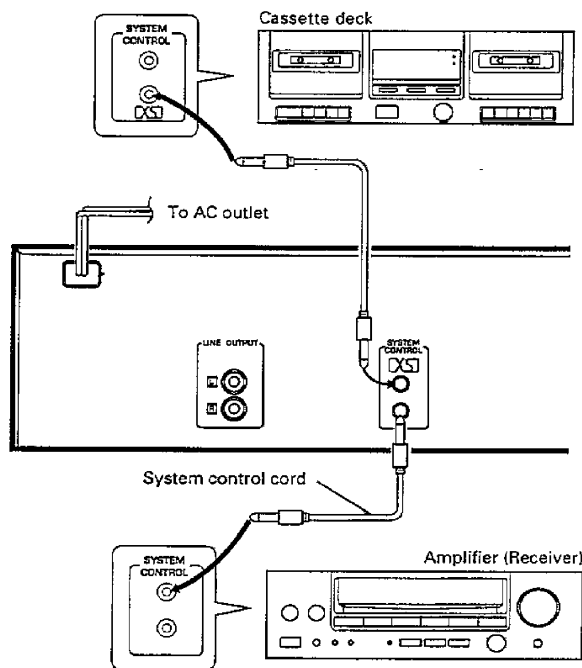
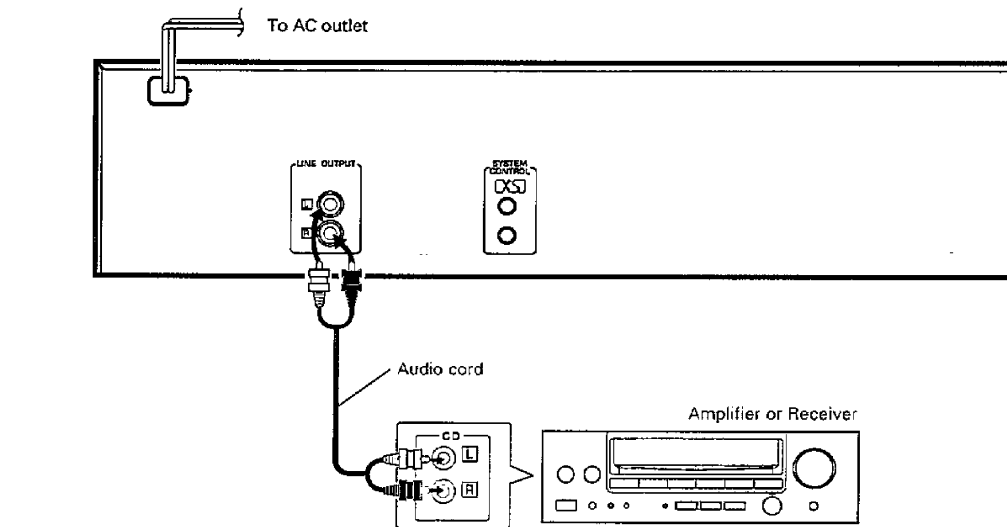

System control connection

When connected to an amplifier having KENWOOD SYSTEM CONTROL terminals, system operation such as remote control is made possible. For details, refer to the instruction manual of the amplifier or receiver.

If your amplifier or receiver is not equipped with the SYSTEM CONTROL terminals, do not connect anything to any SYSTEM CONTROL terminal.

Do not connect the unit in any system configuration other than specified.

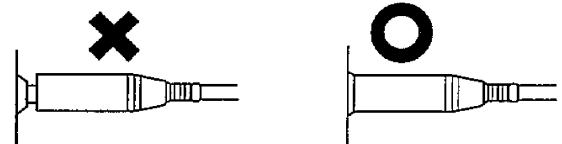

- Be sure to insert the system control cord plugs fully into the SYSTEM CONTROL terminals.
- If the system control cord and audio cords are not connected properly, the automatic system governing remote control and system functions will not operate.

CCRS

By connecting the SYSTEM CONTROL terminal of this unit with the "XS" SYSTEM CONTROL terminal of a KENWOOD cassette deck, CCRS recording can be carried out.

The CCRS function is used when recording from a CD to a tape in a cassette deck, and operates to adjust the cassette deck's recording level to the optimum setting according to the playing level of the CD. For details on the CCRS function, refer to the instruction manual provided with your cassette deck.

One System control cord is supplied with this unit.

When connecting more than one component for System control operation, use the System control cords provided with the other components.

Notes:

1. Connect all cords firmly. If connections are loose, there could be loss of sound or noise produced.
2. When plugging and unplugging connection cords, be sure to first remove the power cord from the AC outlet.
Plugging/unplugging connection cords without removal of the power cord can cause malfunctions or damage to the unit.

Controls and indicators

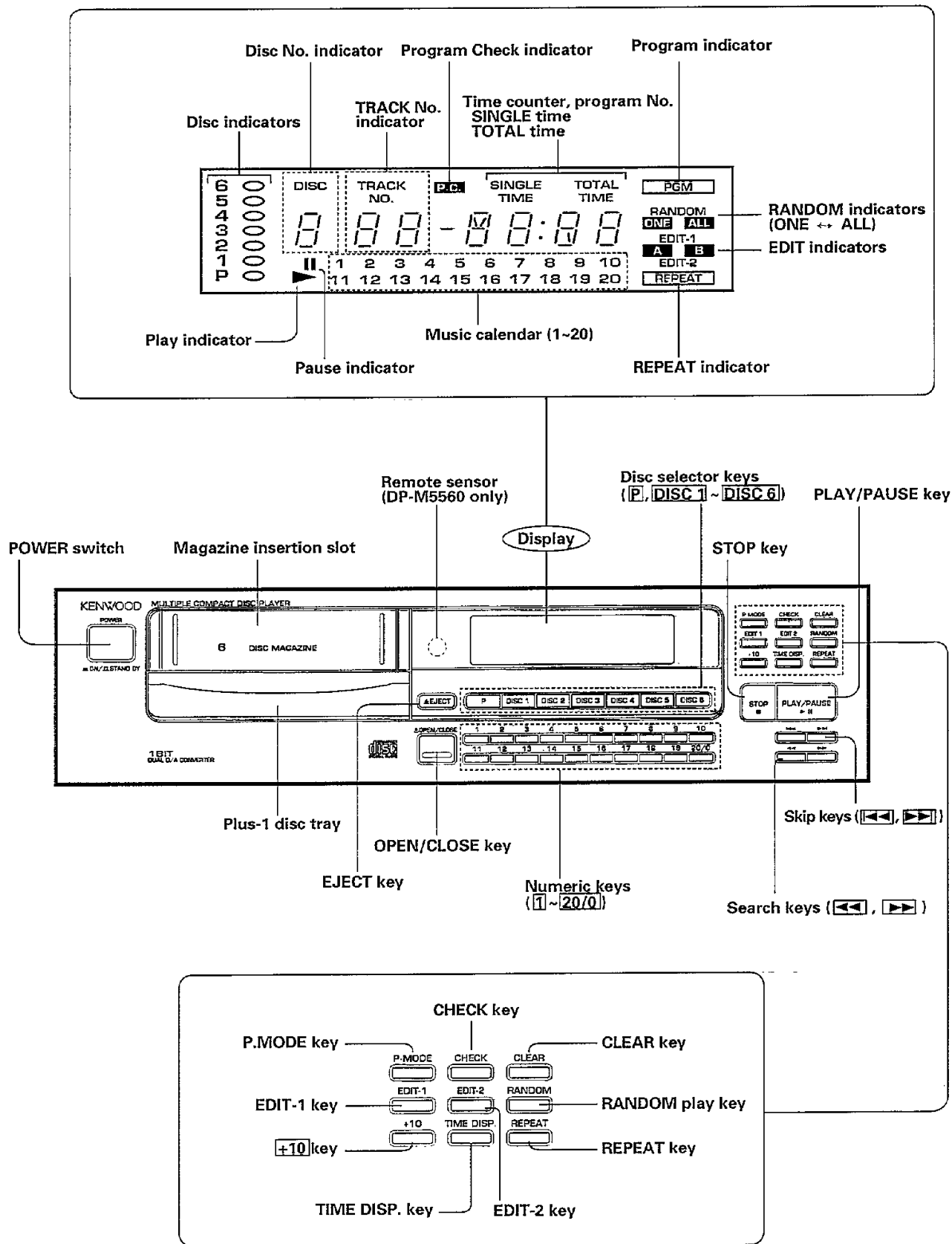

Operation of remote control unit (DP-M5560 only)

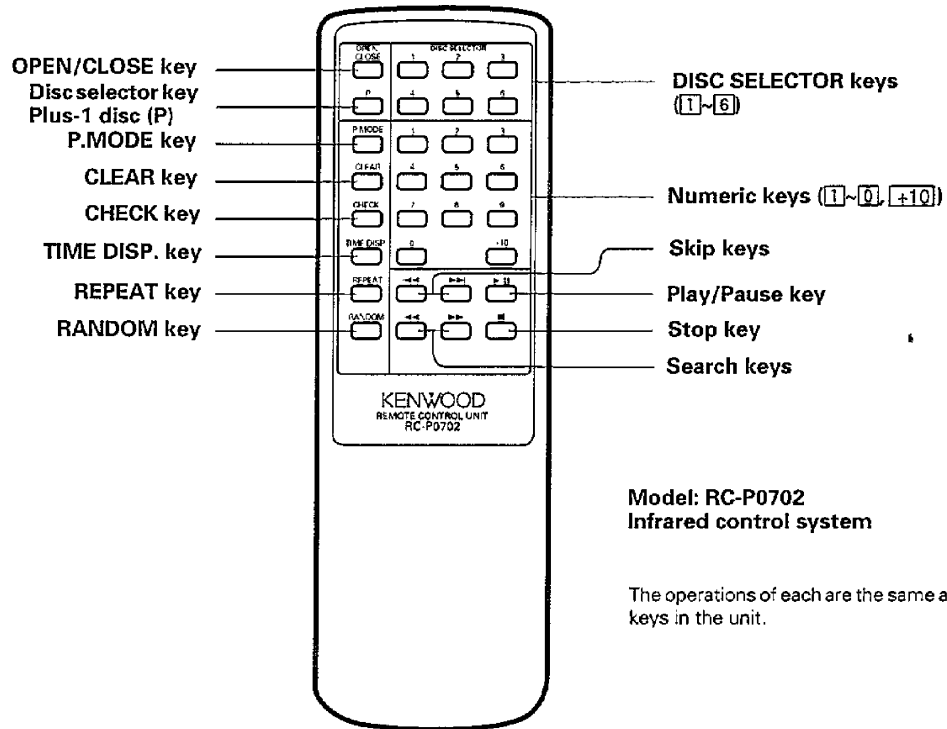

Model: RC-P0702
Infrared control system

The operations of each are the same as those of the keys in the unit.

■ Loading batteries

- 1** Remove the cover.

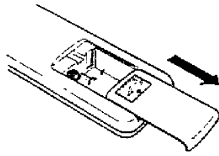

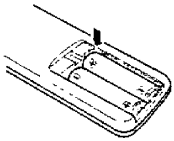
- 2** Insert batteries.

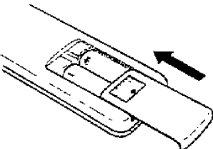
 - Insert two (R6/AA) size batteries as indicated by the polarity marking.
- 3** Close the cover.

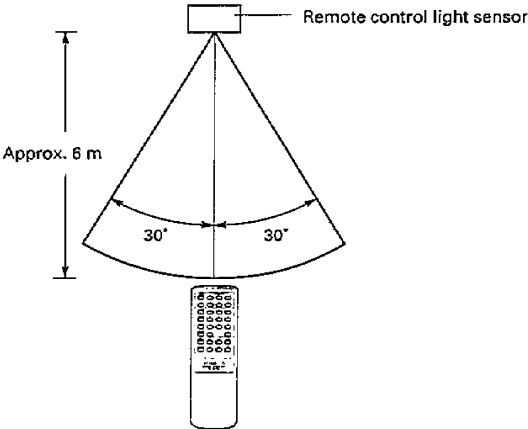

■ Operation procedure

Operating range



- When two operation keys on the remote control unit are pressed successively, press each key securely reserving an interval of more than 1 second for each press.

Notes:

1. The supplied batteries are intended for use in operation checks. Therefore, their lives may be shorter than ordinary batteries.
2. When the remote-controllable distance gets shorter than before, replace both batteries with new ones.
3. Malfunction may occur if direct sunlight or the light of a high-frequency lighting fluorescent lamp enters the remote control light sensor. In such a case, change the system installation position to prevent the malfunction.

Before operation

Disc handling precautions

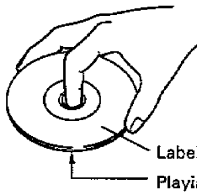

Handling

Hold compact discs so that you do not touch the playing surface.

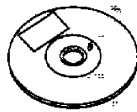

Do not attach paper or tape to either the playing side or the label side of compact discs.

Caution on disc used

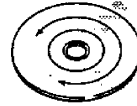
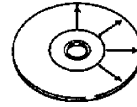
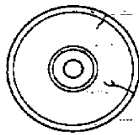

Cleaning

If fingerprints or foreign matter become attached to the disc, lightly wipe the disc with a soft cotton cloth (or similar) from the center of the disc outwards in a radial manner.

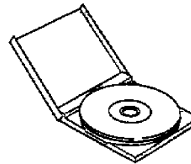

Storage

When a disc is not to be played for a long period of time, remove it from the CD player and store it in its case.

Never play a cracked or warped disc.

During playback, the disc rotates at high speed in the player. Therefore, to avoid danger, never use a cracked or deformed disc or a disc repaired with tape or adhesive agent.

Note related to transportation and movement

Before transporting or moving this unit, carry out the following operations.

1. Turn the power ON but do not load a disc or magazine.
2. Wait a few seconds and verify that the display shown appears.
3. Turn the power OFF.

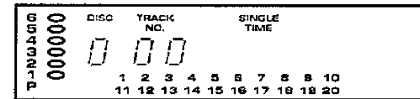

Beware of condensation

When water vapor comes into contact with the surface of cold material, water drops are produced.

If condensation occurs, correct operation may not be possible, or the unit may not function correctly.

This is not a malfunction, however, and the unit should be dried. (To do this, turn the POWER switch ON and leave the unit as it is for several hours.)

Be especially careful in the following conditions:

- When the unit is brought from a cold place to a warm place, and there is a large temperature difference.
- When a heater starts operating.
- When the unit is brought from an air-conditioned place to a place of high temperature with high humidity.
- When there is a large difference between the internal temperature of the unit and the ambient temperature, or in conditions where condensation occurs easily.

For CANADA

DOC REGULATION

"This digital apparatus does not exceed the CLASS B limits for radio noise emissions from digital apparatus as set out in the radio interference regulations of the Canadian Department of Communications."

For the U.S.A.

FCC WARNING:

This equipment may generate or use radio frequency energy. Changes or modifications to this equipment may cause harmful interference unless the modifications are expressly approved in the instruction manual. The user could lose the authority to operate this equipment if an unauthorized change or modification is made.

NOTE:

This equipment has been tested and found to comply with the limits for a Class B digital device, pursuant to Part 15 of the FCC Rules. These limits are designed to provide reasonable protection against harmful interference in a residential installation. This equipment may cause harmful interference to radio communications, if it is not installed and used in accordance with the instructions. However, there is no guarantee that interference will not occur in a particular installation. If this equipment does cause harmful interference to radio or television reception, which can be determined by turning the equipment off and on, the user is encouraged to try to correct the interference by one or more of the following measures:

- Reorient or relocate the receiving antenna.
- Increase the separation between the equipment and receiver.
- Connect the equipment into an outlet on a circuit different from that to which the receiver is connected.
- Consult the dealer or an experienced radio/TV technician for help.

Before playing CDs

■ Loading a disc into the magazine

1 Pull out the disc tray.

① While pressing in on the lock button

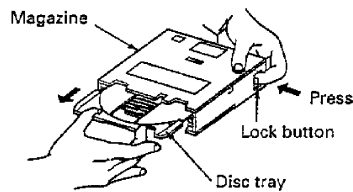

② Pull out the disc tray.

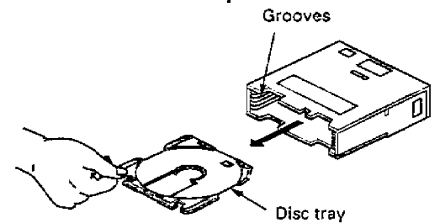

2 Place a disc on the disc tray.

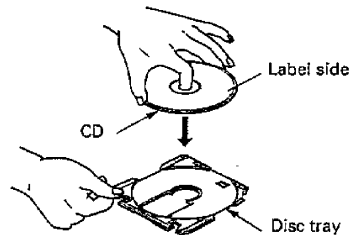

- Commercially-available CD single (8 cm) disc adapters cannot be used in this system. To play CD single (8 cm) discs, use the optional CDM-608 CD single magazine.

3 Insert the disc tray into the magazine.

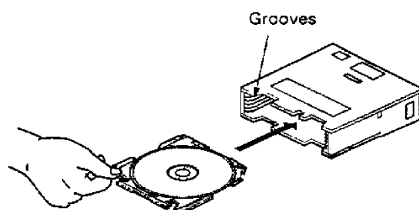

Align the tray with the corresponding left and right grooves and insert horizontally into the magazine.

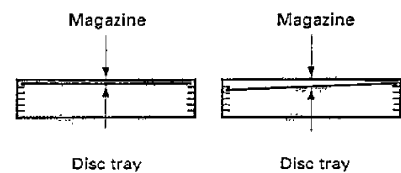

- Be sure to place each disc on a disc tray before inserting into the magazine.
- Even when loading fewer than six discs, make sure there are six disc trays inserted in the magazine during use.
- Always hold the magazine level when carrying.

■ Loading a magazine

① Press the POWER key to ON.

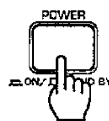

② Insert the magazine.

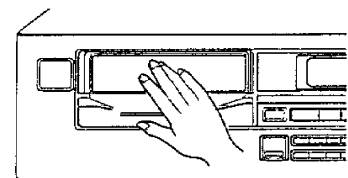
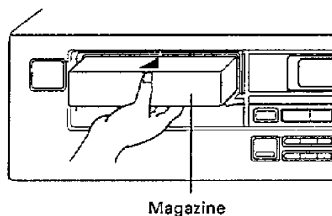

Press in until it locks in place with a click.

■ Loading a disc in the plus-1 disc tray

① Open the plus-1 disc tray.



② Place a disc on the tray.

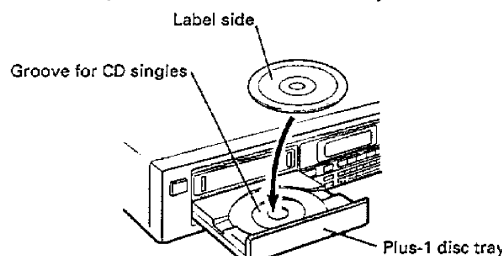

③ Close the plus-1 disc tray.



Normal playback

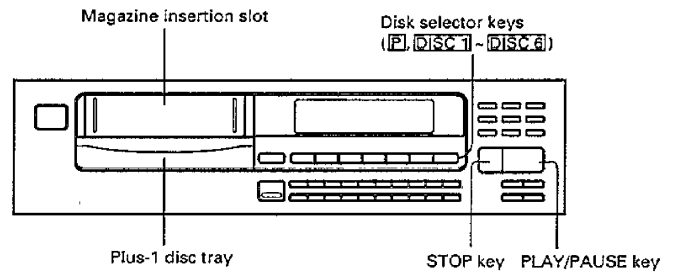

■ Playing a CD from the beginning

1 Place a disc in the magazine or on the plus-1 disc tray.

(Refer to page 7.)

All disc indicators light regardless of how many discs are in the magazine.

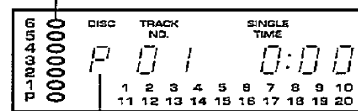

Plus-1 disc

2 Start playback.

Select the desired disc.



If there is no disc in the selected disc tray, the corresponding indicator goes out.

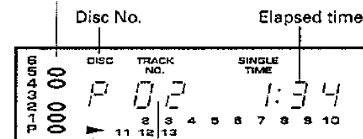

TRACK No.
Lights up.

- Playback starts from the selected disc. If two or more discs are loaded, the discs are played in order of their disc numbers.
- If the play key is pressed without selecting a disc, the discs will be played automatically in the following order: P → 1 → 2 → 3 → 4 → 5 → 6. (P: Plus-1 disc tray)
- To play a single disc only, remove the magazine and place a disc only in the plus-1 disc tray.

To pause playback

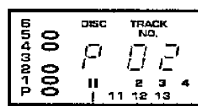

Lights up.

To resume playback, press the key again.

To stop playback



■ Remove the magazine

① Press the eject key.

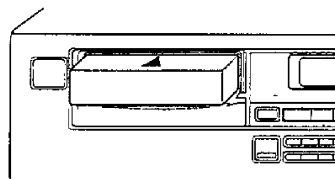

② Pull out the magazine.

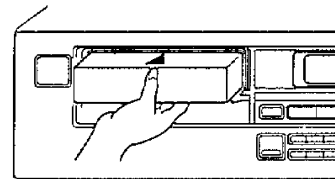

Hold the magazine in the center.

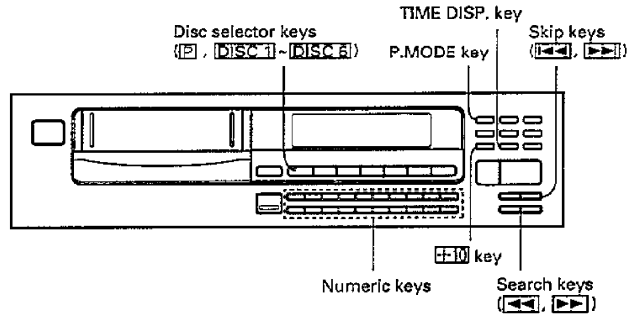

■ Listening from the desired track

1 Make sure the PGM indicator is extinguished.



- If the PGM indicator is lighted, press the P.MODE key.

2 Select the desired disc.



3 Select the desired track.

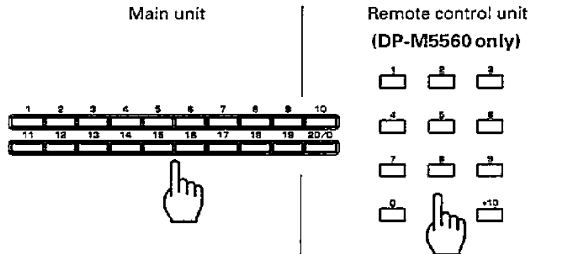

Examples of input

Track No. 11: 11
Track No. 20: 20/0
Track No. 30: +10 +10
+10 20/0

Examples of input

Track No.11: +10 1
Track No.20: +10 +10 0
Track No.30: +10 +10
+10 0

- Play starts from the selected tune and after.

To skip tracks

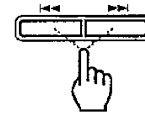

- The tunes are skipped in the direction of the key and the play starts at the beginning of the selected tune.
- When the ◀ key is pressed once during play, the track starts again from the beginning. (If pressed again, the play position returns to the preceding track.)

To fast forward and backward

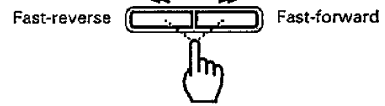

- The track will start to play from where you release the key.

TIME DISP. key

Press the TIME DISP. key when you want to check the elapsed time and remaining time of the track being played. Every time the TIME DISP. key is pressed, the displayed time changes as shown below.

The time information display may not appear when playing a CD containing 21 or more tracks. In such a case, the display (remaining SINGLE TIME) will show "--:--". (However, only the SINGLE TIME can be displayed during random playback and program playback.)

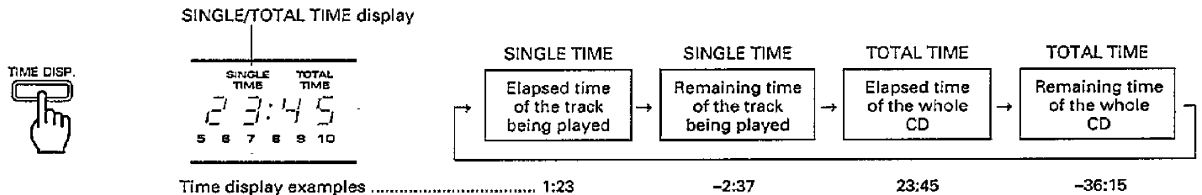

Program playback

The program mode allows you to play desired tracks of 7 discs in the order you want to listen to. A maximum of 20 selections can be entered in memory.

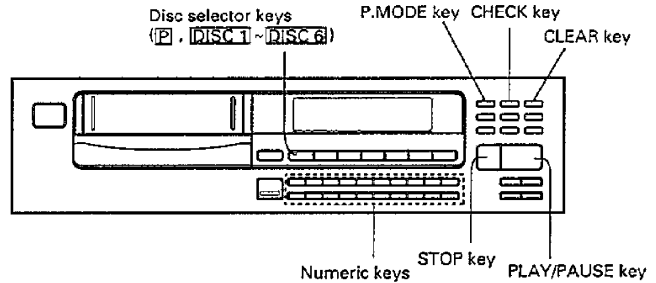

■ Playing desired tracks in desired order (PGM mode)

1 Enter the PGM mode.

Press the **P.MODE** key.

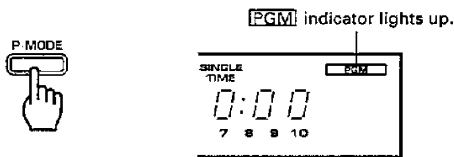

2 Program desired tracks in desired order.

Example

To select track no.5 on disc 4:

① Select the disc.

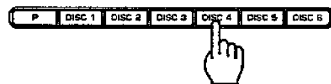

② Select the track.

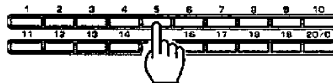

- Repeat steps ① and ② to program up to 20 tracks. After 21 or more tracks are selected, "--P--" is displayed.

To program all tracks on a disc:
Omit step 2-②.

- If more than eight seconds elapse before proceeding to step 2-2, all tracks on the selected disc will be programmed.

If you make a mistake during entry:
Press the **CLEAR** key and re-enter the correct number.

3 Start playback.



- Tracks are played in the order they are programmed (P-No.).
- If one of the skip keys (▶▶ or ◀◀) is pressed during programmed playback, the track being played is skipped in the forward or reverse direction.

To check the programmed order

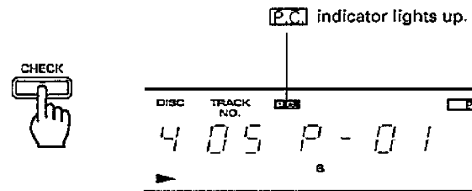

- Every time the **CHECK** key is pressed, the track No., DISC No. and the order it was programmed (P-No.) are displayed in the order of programming.
- The previous display will resume in a few seconds.

To resume normal playback

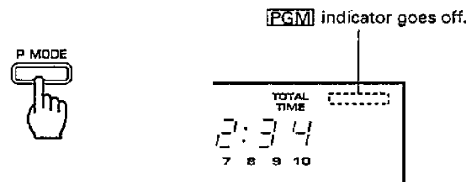

- The playback in the order of the track Nos. on CD will start after the track being played.

To stop programmed playback



Note:

If the magazine does not contain a disc corresponding to the disc No. selected in step 2-①, the disc and track are programmed but cancelled at the time of playback.

■ To add a track to the program

Select the track No. to be added.

- ① Select the disc.



- ② Select the track number.

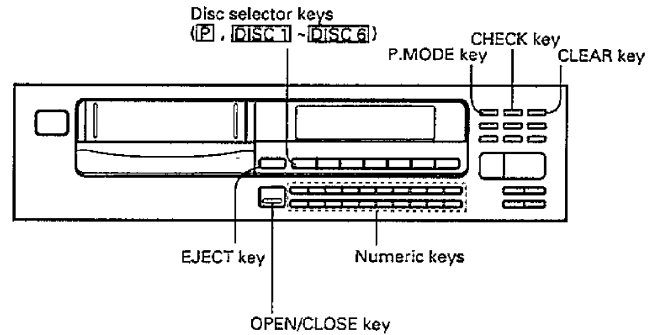

■ To change a track in the program

- 1 Press the CHECK key.

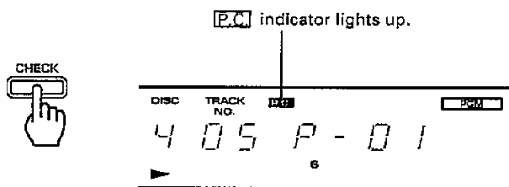

Press until the P-No. to be changed is displayed.

- 2 Select the track No. to replace the previous one.

- ① Select the disc.



- ② Select the track number.

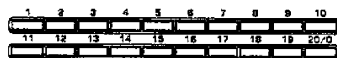

Press while the **P.C.** indicator is lighted.

- The track being played cannot be changed.

■ To clear tracks from the program

Clearing from the last track



- Every time the key is pressed, tracks are cleared from the last track in order.
- The currently playing track cannot be deleted.

Clearing the whole of program

Press any one of these keys.

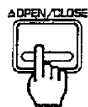

Auto-Space function

In the program mode, a space of about 4 seconds is inserted automatically between the programmed tracks. This function is provided to facilitate the DPSS function of the cassette deck. However, such a space may also be inserted in case the sound of two tracks are continued, for example with some classic music and live recordings.

Repeated playback

■ Repeated playback

Repeated playback of programmed tracks

1 Enter the PGM mode.

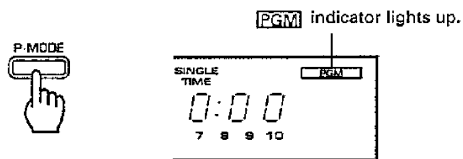

2 Select the desired track(s). (Refer to page 10.)

① Select the desired disc.



② Select the desired tracks.

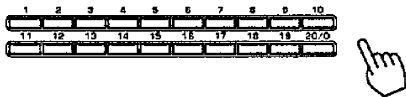

- When you want to repeat only one track, go to step 3 below.
- Repeat steps ① and ② to program up to 20 tracks.

3 Press the REPEAT key.

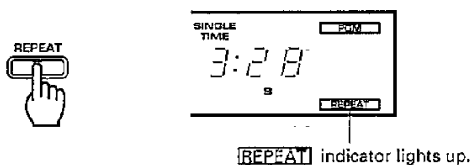

4 Start playback.



- All of the selected tracks will be played repeatedly.
- If only one track is selected, that track will be played repeatedly.

Repeated playback of the whole CDs

1 Make sure the PGM indicator is extinguished.

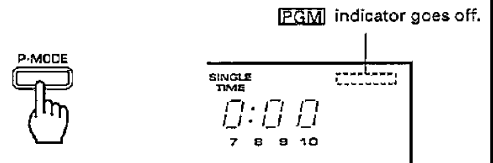

- If the PGM indicator is lighted, press the P-MODE key.

2 Press the REPEAT key.

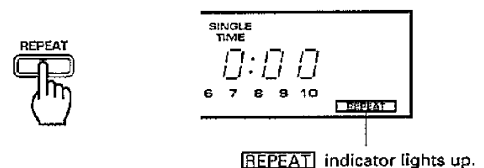

3 Start playback.



- All tracks on all discs in the magazine and Plus 1 tray will be played repeatedly.

Repeating the Plus 1 Tray action only.

① Enter the PGM mode.



② Select the Plus 1 Tray.



- Wait 8 seconds.

③ Press the REPEAT key.



④ Start playback.



- All the tracks of the disc inside the Plus 1 tray will playback repeatedly.

To resume normal playback

Press the REPEAT key again.

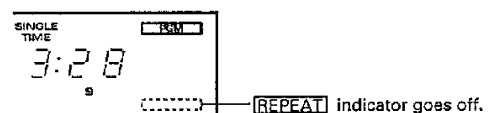

- The playback will be resumed under the CD player mode set before the repeat.

Random playback

This function allows for random selection of the tracks each time and continuous playing in any order. It lets you enjoy hours of tireless track listening.

■ Playing tracks in a random order

1 Make sure the PGM indicator is extinguished.



- If the **PGM** indicator is lighted, press **P.MODE** key.

2 Select the desired random mode.

To randomly play a single disc

① Select the disc.

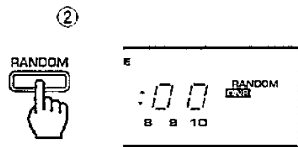
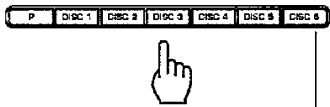

Select **RANDOM ONE**.

To randomly play all discs



Select **RANDOM ALL**.

Each press changes the random mode as shown below.

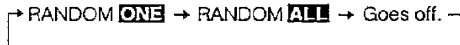

- Tracks on one disc are selected in a random order and played.

- Tunes are selected and played at random from all of the discs.

Note:

The same track will not play twice over continuously, however, it may happen that the same track is repeated later in play.

Timer operations

This unit incorporates a built-in timer standby function. By using an audio timer optionally available in the market, wake-up playback can be started at any time of the day.

Preparations for timer playback

Connect the power cords of the components to the timer so that their powers can be turned on via the timer. Read carefully the instruction manual of your audio timer.

Timer playback

- ① Set the power switches of the components to ON.
- ② Place a disc in the magazine or on the plus-1 disc tray. (Refer to page 7.)
- ③ Set the amplifier volume.
- ④ Set the timer at the desired time of the day.

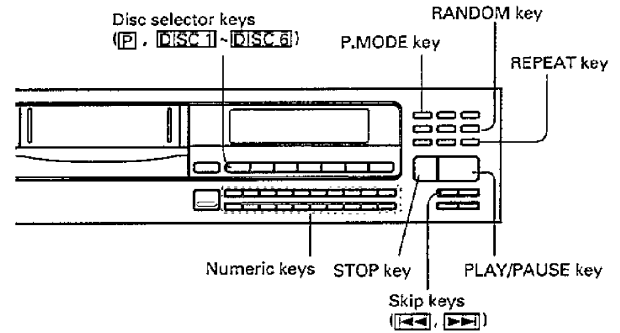

To select another track during random play

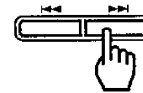

- When the **←** key is pressed once during random play, the track starts again from the beginning.

To cancel random play

Press to off.

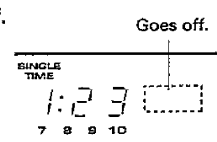

Goes off.

Each press changes the random mode as shown below.

RANDOM ONE → **RANDOM ALL**

Goes off.



- Normal play starts from the track being played.

- Playback stops.

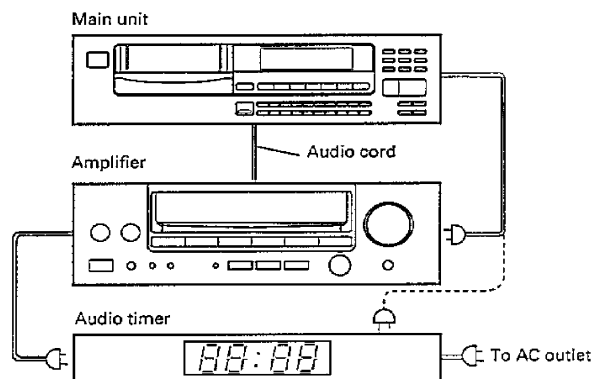

- When operating the unit other than CD player using an audio timer, be sure to remove the disc or the magazine from the CD player.

Editing

When recording tunes from one or more CDs onto a tape, this function edits the tunes to ensure that the tunes fit within the specified tape length and that the last tune on either side does not get cut off in the middle. Two edit keys, EDIT-1 and EDIT-2, allow you to edit two different discs separately. This is convenient for times when you want to record two tapes in succession.

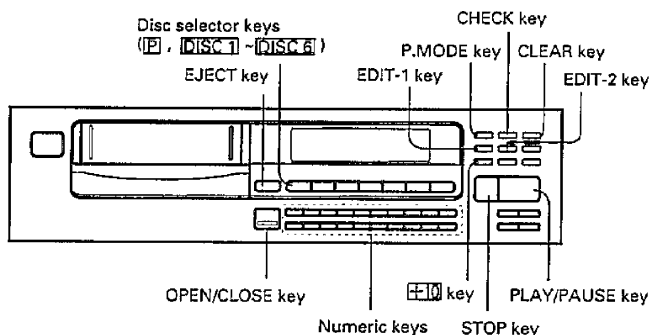

To edit a disc

1 Press the STOP key.



- Make sure the PGM indicator is extinguished.

2 Press the EDIT-1 key.

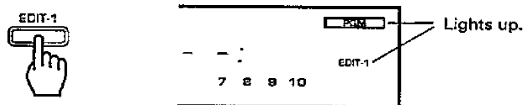

- You cannot use the EDIT-2 key until the first disc has been edited using the EDIT-1 key.

3 Select the disc you want to edit.

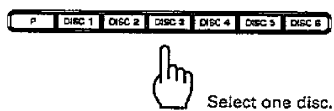

- Editing using two or more discs at one time is not possible.

4 Enter the tape length.

Example
 For C-46: +10 +10 +10 +10 6
 For C-30: +10 +10 +10 20/0

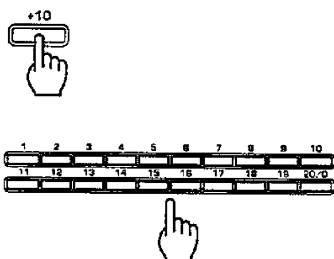

Editing is carried out as follows.

- (1) The specified tape length is divided in half, then as many tunes as will fit in the A file (side A of the tape) are selected starting with the small track numbers.

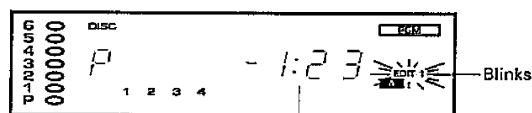

Remaining time in file A

- (2) After a few seconds the remaining time left in the A file appears on the display, then the B file (side B of the tape) is edited in the same manner.

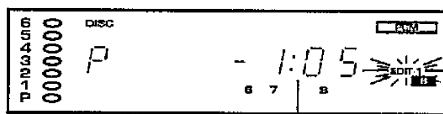

Remaining time in file B

- If you press the STOP key or OPEN/CLOSE key while editing is being carried out, editing is interrupted and stops.

Editing completed

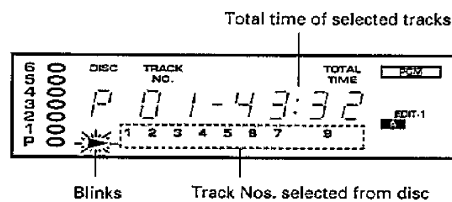

To edit a second disc

Press the EDIT-2 key in step 2, then perform steps 3 and 4 in the same manner as for the first disc.

■ To check the edited program contents

Press the CHECK key.

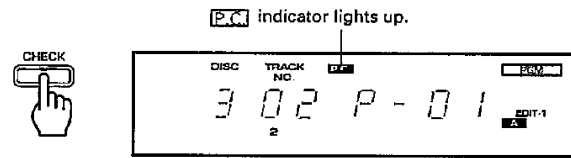

- Every time the CHECK key is pressed, the track Nos. are displayed in the edited order.

■ To play an edited program

① To play the A file:



The tunes in the A file are played in sequence and the player enters pause mode at the beginning of the B file.

② To play the B file:



To play the second disc (EDIT-2):
Repeat steps ① and ② above.

- Playback stops after having played the B file.

Notes:

1. While you can edit with a different time setting to that of the tape you are using, part of the tape may be left with nothing recorded on it, or the last track on side A or side B may be cut short.
2. Up to a maximum of 20 tracks can be edited using this function.
3. The EDIT function may not operate properly for discs having only one track or having tracks of long duration such as classical music.

■ To record an edited program

The CCRS recording function may be used by connecting the CD player to any KENWOOD cassette deck with an "XS" mark, using a system control cord. If connected to a cassette deck that is able to relay recording, material edited using the EDIT-1 and EDIT-2 keys can be continuously recorded. For details please refer to "Recording of CD playback" section in your cassette deck instruction manual.

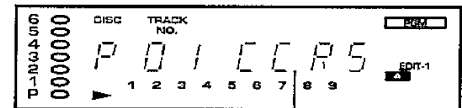

CCRS display

■ To erase the edited contents

Press any one of these keys.

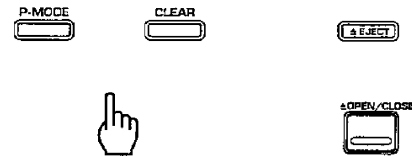

- The whole of the edited contents are cleared.

The marking of products using lasers (Except for some areas.)

**CLASS 1
LASER PRODUCT**

The label is attached to the rear panel and says that the component uses laser beams that have been classified as Class 1. It means that the unit is utilizing laser beams that are of a weaker class. There is no danger of hazardous radiation outside the unit.

For the U.S.A.

CAUTION:

Use of controls or adjustments or performance of procedures other than those specified herein may result in hazardous radiation exposure.

In compliance with Federal Regulations, following are reproductions of labels on, or inside the product relating to laser product safety.

KENWOOD CORPORATION
SHIONOGI SHIBUYA BUILDING 17-5,
2-CHOME, SHIBUYA, SHIBUYA-KU,
TOKYO, JAPAN

KENWOOD CORP. CERTIFIES THIS EQUIPMENT CONFORMS TO DHHS REGULATIONS NO.21 CFR 1040.10, CHAPTER I, SUBCHAPTER J.

Location: Back Panel

In case of difficulty

What appears to be a malfunction may not always be serious. If your unit should not perform as expected, consult the table below to see if the problem can be corrected before seeking help from your dealer or service representative.

Symptom	Cause	Remedy
No power is applied with the POWER switch ON.	<ul style="list-style-type: none"> Power plug is loosely connected. With the power plug connected to the switched AC outlet of an amplifier, the power of the amplifier is turned off. 	<ul style="list-style-type: none"> Insert the power plug firmly into the AC outlet. Turn the amplifier's power ON.
Disc is loaded, player does not play.	<ul style="list-style-type: none"> Disc is loaded upside down. Disc is loose. Disc is dirty. Disc is cracked. Condensation occurred on the optical lens unit. 	<ul style="list-style-type: none"> Load the disc again with its label side up. Insert the disc properly. Wipe off the dust on the surface of the disc referring to "Disc handling precautions". Replace the disc with a new one. Leave the player for about 1 hour so that the condensation is removed.
No sound.	<ul style="list-style-type: none"> Disc is not loaded. Play mode is not entered (The play/pause indicator is not lit.) Disc is too dirty. Disc is cracked. The connection cords are inserted loosely. 	<ul style="list-style-type: none"> Load a disc. Press the [▶/⏸] key. Wipe off the dust on the disc surface referring to "Disc handling precautions". Replace the disc with a new one. Connect all connection cords firmly.
Music is interrupted. (Sound is skipped.)	<ul style="list-style-type: none"> Disc is too dirty. Disc is cracked. Oscillation is applied to this unit. 	<ul style="list-style-type: none"> Wipe off the dust on the disc surface referring to "Disc handling precautions". Replace the disc with a new one. Try selecting a place where no strong vibrations occur by changing the installation place, etc.
Play begins as soon as the power is turned on.	<ul style="list-style-type: none"> This unit is designed so that play begins automatically when the power is turned on if a disc or a magazine is already loaded. 	<ul style="list-style-type: none"> If automatic play is not required, remove the disc or the magazine from the player before turning the power OFF.

Notes:

- This system is microprocessor-controlled, so malfunction may occur due to external noise or interference noise. In such a case, unplug the power cord, plug it and turn power on again.
- Do not use contact cleaners because it could cause a malfunction. Be specially careful against contact cleaners containing oil, for they may deform the plastic components.

Specifications

[Format]

System Compact disc digital audio system
 Laser Semiconductor laser
 Number of channels 2 channels
 playing rotation 200 rpm ~ 500 rpm (CLV)

[D/A Converters]

D/A conversion 1 Bit
 Oversampling 8 fs

[Audio]

Frequency response 8 Hz ~ 20 kHz ± 1.0 dB
 Signal to noise ratio More than 96 dB
 Dynamic range More than 94 dB
 Total harmonic distortion
 Less than 0.005% (at 1 kHz)

Channel separation More than 90 dB (at 1 kHz)
 Wow & flutter Unmeasurable limit
 Output level/impedance
 Fixed 2.0 V/3.3 kΩ

[General]

Power consumption 15 W
 Dimensions W: 440 mm (17-5/16")
 H: 128 mm (5-1/16")
 D: 360 mm (14-3/16")
 Weight (net) 5.4 kg (11.9 lb)

Note:

KENWOOD follows a policy of continuous advancements in development. For this reason specifications may be changed without notice.